

Comparison of Optical Processing Techniques for Optical Microwave Signal Generation

Arthur James Lowery, *Senior Member, IEEE*, and Phil C. R. Gurney, *Member, IEEE*

Abstract—Recently, there have been several proposals on using the higher RF harmonics of detected pulses from mode-locked semiconductor lasers as a source of microwave and millimeter waves. This paper compares the performance of three optical techniques of signal processing that have been proposed to select a higher harmonic of a mode-locked laser, by using extensive numerical simulations. We show that techniques using delays and splitters are insensitive to the coherence properties of the source, but can introduce amplitude patterning if pulses overlap when recombined. We see that techniques relying on optical filtering to select optical modes require extremely high- Q filters and, thus, are extremely sensitive to tuning. A Fabry–Perot interferometer (FPI) is the optimum filter method in terms of power efficiency for low harmonics, but using two separate bandpass filters can give comparable efficiency when selecting higher harmonics. We also show that gain-switched lasers are unsuitable as sources when used with narrow-band optical filtering techniques because of their low pulse-to-pulse optical coherence.

Index Terms— Modeling, mode locking, optical communications systems, optical fiber transmission, optical microwave signal generation, semiconductor lasers.

I. INTRODUCTION

NOVAK and Tucker [1] have proposed the generation of microwave carriers by selecting a harmonic of the output of a mode-locked semiconductor laser driven at a lower frequency. The technique uses a Fabry–Perot optical filter aligned to select widely spaced optical modes which then mix at a photodetector to give a microwave signal at the difference frequency between the selected modes. Other harmonics of the laser drive frequency are suppressed by the removal of closely spaced optical modes. The applications of this technique, which are shown in Fig. 1, include the following.

- (1) Increasing the ratio of the RF power at the desired harmonic to the mean optical power squared, thereby reducing restrictions due to saturation in optical amplifiers and photodiodes [2]. This advantage is only gained for optical pulses wider than $0.26/f$, where f is the desired RF frequency, as shown in [2, eq. (5)].
- (2) Eliminating unwanted harmonics before the optical signal is modulated with data, so that wider modulation bandwidths can be used without unwanted mixing products (from the unwanted harmonics) being generated.

- (3) Eliminating the need for electrical filtering after the photodiode. This is an advantage if the optical signal is to be broadcast to many sites, as many electrical filters are saved for the cost of one optical processor.

There are a variety of other techniques by which the optical signal can be processed to modify the baseband spectrum, including: 1) delay lines [3], [8]; 2) fiber Bragg gratings [4]; 3) interferometers [1], [2], [5]; 4) multiple bandpass filters [6]; and 5) pulse compression techniques [7]. It is unclear, at present, which of these techniques gives the optimum performance, and whether there are any particular difficulties in implementing these schemes.

In this paper, we compare three methods of processing the optical signal, which are shown in Fig. 2. The first technique is to increase the pulse repetition frequency by splitting the output of a mode-locked laser into two paths, delaying one path, and then recombining the paths (*split–delay–recombine method*) [8]. The second is to use a Fabry–Perot interferometer (FPI) with its free-spectral range (FSR) set to the desired microwave output frequency [2]. The third is to split the signal, use two bandpass filters to select two optical modes, and use a coupler to recombine the optical fields from these filters before photodetection [6].

We show that the essential feature of all schemes is to store energy from a mode-locked pulse, and to use this energy to fill in the gaps between the original pulses to increase the pulse repetition frequency of the optical pulse train, and thus suppress the output at the original drive frequency. Thus, high- Q optical filters with long time constants are required. However, in practice, such filters are difficult to set up and keep in tune. The *split–delay–recombine method* relies on the delay for energy storage, and thus has some advantages. However, it can only suppress some harmonics, and can introduce amplitude patterning if the combined pulses overlap.

Section II discusses the numerical model. The three processing techniques are discussed in detail and simulation results are presented in Section III. Section IV covers the use of a gain-switched laser as a source of pulses, and Section V contains conclusions.

II. NUMERICAL MODEL

A comprehensive large-signal numerical model, the transmission-line laser model (TLLM) [9], was used to simulate a typical mode-locked laser. This has been incorporated into the *Optoelectronic Photonic and Advanced*

Manuscript received August 19, 1996; revised November 21, 1997.

The authors are with the Australian Photonics Cooperative Research Centre, Photonics Research Laboratory, Department of Electrical and Electronic Engineering, University of Melbourne, Parkville, Vic. 3052, Australia (e-mail: a.lowery@ee.mu.oz.au).

Publisher Item Identifier S 0018-9480(98)01590-7.

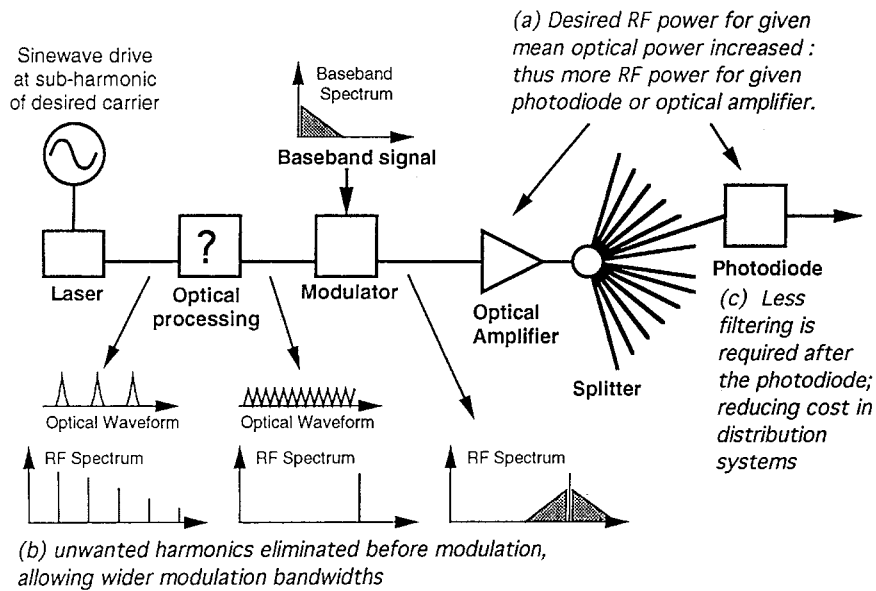

Fig. 1. Applications of optical processing to obtain microwave signals. (a) Increasing RF power for a given mean optical power. (b) Elimination of unwanted harmonics before modulation. (c) Elimination of post-photodiode filtering in distribution networks.

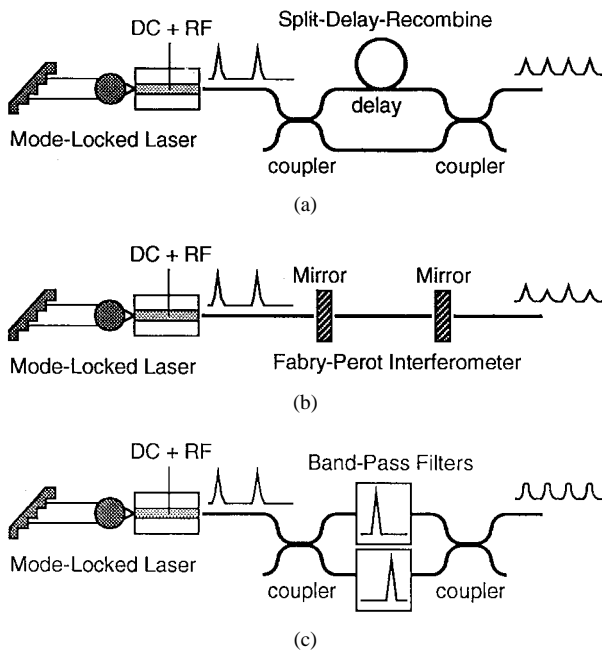

Fig. 2. Three techniques for optically processing the output of a mode-locked laser to obtain RF power at a harmonic of the drive frequency. (a) Split-delay-recombine method. (b) FPI method. (c) Two filter method.

*Laser Simulator (OPALS).*¹ OPALS includes models of most available photonic components, which appear as icons. The icons can then be “wired” together to form a simulation of a photonic circuit or system. OPALS can simulate over a large optical bandwidth, includes forward and backward propagating waves, and simulates laser noise mechanisms. The large optical bandwidth allows the study of the effects of filters on optical spectra, the backward waves allow resonators to be made from

¹ *Optoelectronic Photonic and Advanced Laser Simulator* is a product of Virtual Photonics Pty Ltd., Australia (info@vp.com.au; www.vp.com.au).

several components, and the noise mechanisms allow the noise of sources to be investigated. OPALS also includes a range of instrumentation to allow data to be gathered and analyzed.

The mode-locked laser under simulation had a grating-controlled external cavity [10] with a 70-GHz optical bandwidth grating centered on 1550 nm, and a 300- μm -long laser chip. The laser model was constructed from a laser chip model connected to an optical cavity model, which included optical filters to represent the diffraction grating [11]. The laser was fed with a dc bias of 26 mA (109% of threshold), and a drive of 68 mA peak-peak at a frequency of 2.39 GHz. This bias was selected to prevent the pulses from having secondary peaks [12], and gave a continuous wave (CW) output power of 450 μW . The drive frequency was tuned to below the resonant frequency of the cavity, ensuring that the pulse train was stable [13]. The laser oscillated in a single-chip mode due to the laser’s chip being perfectly antireflection coated. A complete set of laser parameters is given in Table I, with definitions as in [14]. The model’s timestep was 0.25 ps, giving an optical bandwidth of 2 THz.

The mode-locked laser was monitored with simulated instrumentation comprising: 1) an optical spectrum analyzer based on a 16-K point fast Fourier transform (FFT) with a Blackman-Harris window function measuring optical power into 1-Hz bandwidth; 2) a high-speed photodiode and oscilloscope with a combined bandwidth of 140 GHz; and 3) an RF spectrum analyzer with a resolution bandwidth of 24.4 MHz, measuring power within this bandwidth into a 50- Ω load assuming a photodiode responsivity of 1 A/W. The spectra were averaged over several transforms to reduce the uncertainty in the traces. In the following results, we focus on selecting microwave (4.8 GHz), and millimeter-wave (38.3 GHz) frequencies using optical processing.

Fig. 3 shows the optical spectrum, pulse waveform, and the RF spectrum of the modulated laser. The optical spectrum has

TABLE I
MODE-LOCKED LASER PARAMETERS

| Parameter | Symbol | Value | Unit |
|---------------------------------------|------------|-----------------------|----------------------------|
| Laser Chip Length | L | 300 | μm |
| External Cavity Length | L_{ext} | 60.4 | mm |
| Active Region Width | w | 3.5 | μm |
| Active Region Thickness | d | 0.18 | μm |
| Laser Waveguide Group Effective Index | n_g | 4.0 | |
| Material Linewidth Enhancement Factor | α | 4.9 | |
| Internal Loss | α_i | 4000 | m^{-1} |
| Confinement Factor | Γ | 0.3 | |
| Right Facet Reflectivity | R_r | 0.3 | |
| Left Facet Reflectivity | R_l | 0.0 | |
| External Cavity Reflectivity | R_E | 0.5 | |
| Nominal Wavelength | λ | 1550 | nm |
| Linear Material Gain Coefficient | a | 3.5×10^{-20} | m^2 |
| Transparency Carrier Density | N_0 | 1.5×10^{-24} | m^{-3} |
| Nonlinear Gain Coefficient | ϵ | 6.0×10^{-23} | m^3 |
| Linear Recombination Coefficient | A | 0.0 | s^{-1} |
| Bimolecular Recombination Coefficient | B | 1.0×10^{-16} | $\text{m}^3 \text{s}^{-1}$ |
| Auger Recombination Coefficient | C | 3.0×10^{-41} | $\text{m}^6 \text{s}^{-1}$ |
| Population Inversion Parameter | n_{sp} | 3.0 | |

18 modes within 10 dB of the peak mode. The skew in the spectrum is probably a result of self-phase modulation of the pulses as they pass through the laser chip [10]. The width of these modes is principally due to the limited resolution of the windowed Fourier transform (FT). The waveform shows a stable pulse train with symmetrical pulses of around 50.7-ps full width at half maximum (FWHM). These pulses have a peak power of 5.4 mW and less than 10% peak-peak long-term amplitude variations. The mean optical power is 700 μW . The RF spectrum shows potential millimeter-wave carriers at the harmonics of the driving frequency, which drop off in power at higher harmonics due to the width of the pulse. If the pulses are short compared with the period of the desired frequency, then we should expect the RF power of each harmonic to be [15]

$$P_{\text{rf}} = 2R_L(\bar{P}_{\text{opt}} \cdot \mathfrak{R})^2 \quad (1)$$

where R_L is the load resistance, \bar{P}_{opt} is the mean optical power, and \mathfrak{R} is the responsivity of the photodiode. This equation predicts -13-dBm RF power into 50 Ω for 700- μW mean optical power. The simulated RF power (into 50 Ω) measured from the spectrum was -13.5 dBm for the fundamental, -14.9 dBm for the 2nd harmonic, and -62 dBm at 38.3 GHz. This confirms that the optical pulses can only be considered as impulses for low-frequency harmonics [2].

The carrier-to-noise ratio (CNR, dBc) of the laser was estimated assuming that the noise power is that within the resolution bandwidth of the RF spectrum analyzer. For example, a noise level of 0 dBm in our RF spectrum translates to -74 dBm/Hz. Thus, the CNR of the 2nd harmonic is 121 dBc/Hz at 100-MHz offset, which is close to the resolution of the FFT. The CNR of the 16th harmonic (38.3 GHz) was 85 dBc/Hz at 100-MHz offset, similar to that obtained by Novak *et al.* [2].

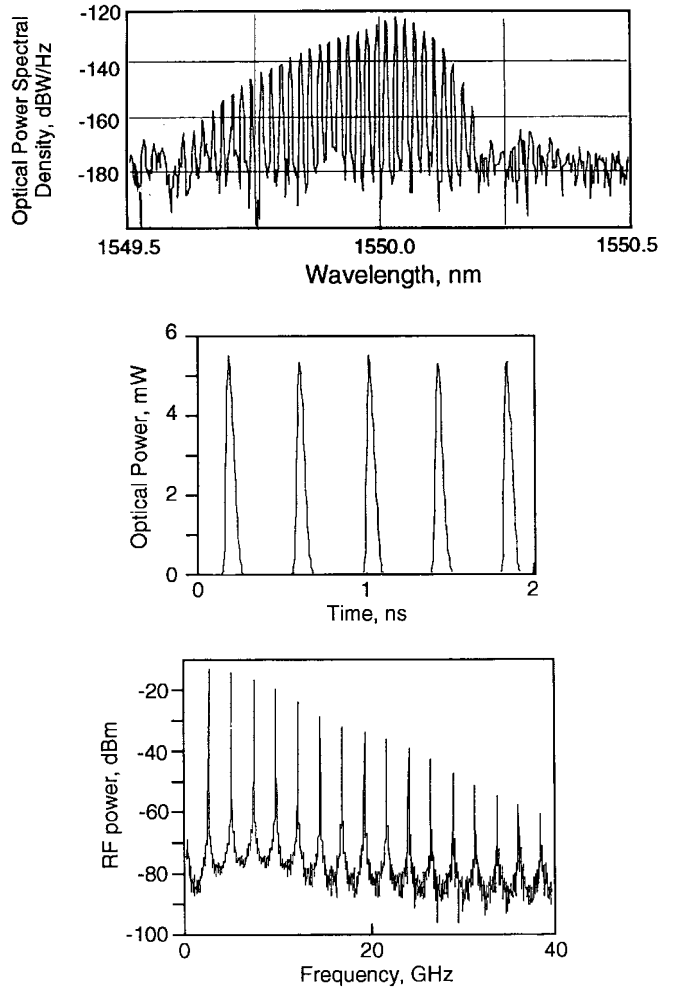

Fig. 3. Simulated optical spectrum, pulse waveform, and RF spectrum of the direct (unprocessed) output of the mode-locked laser.

III. OPTICAL PROCESSING TECHNIQUES

A. Split-Delay-Recombine [Fig. 2(a)]

This is similar to the technique for generating ultrafast pulse trains in optically time-division multiplexed (OTDM) systems [8], where individually modulated low-repetition rate pulses are combined optically to give a high bit-rate data stream. The key to the technique is for the original mark to space ratio of the pulses to be sufficiently small, so the pulses can be interlaced without the optical fields in their tails mixing, which would produce beat frequencies. The lack of mixing of the optical fields in the undelayed and delayed arms also means that the technique is insensitive to the wavelength of the input.

With a single delay, it is only possible to reinforce the even harmonics of the laser drive frequency, and cancel the odd harmonics. Mathematically, the impulse response of the split-delay-recombine system $h(t)$ is simply two delta functions separated by the delay t_{delay} :

$$h(t) = 0.5(\delta(t) + \delta(t - t_{\text{delay}})). \quad (2)$$

The 0.5 factor represents the splitting loss of the couplers. Other combinations of couplers and time delays can be used

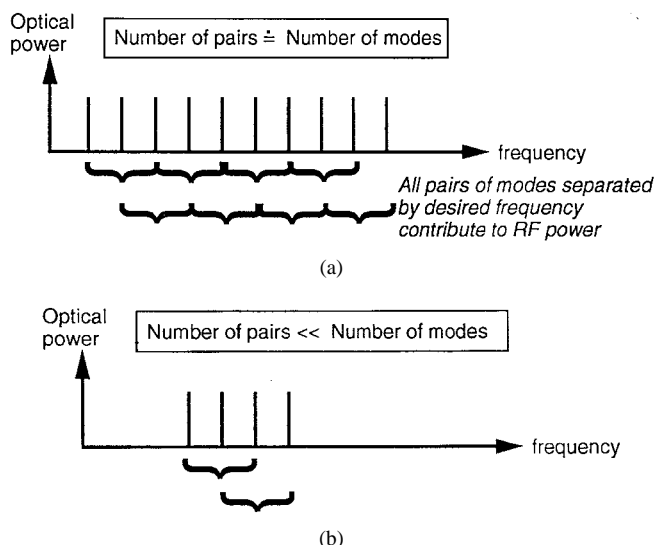

Fig. 4. Method of increasing RF power for a given mean optical power. (a) Wide spectrum: no improvement from filtering. (b) Narrow spectrum: improvement from filtering.

to add more paths and thus interleave more pulses. With n paths it is possible to select the $(m \times n)$ th harmonic where m is an integer. It is desirable that $m = 1$ for the desired frequency, so that the $m = 2$ harmonic is well beyond the frequency response of the photodiode. This is essentially the same as designing a finite impulse response (FIR) digital filter at baseband, if the pulses are short enough so that their tails do not mix.

If the optical pulses approach delta functions, then the RF power in the desired harmonic will be independent of the harmonic number; all harmonics will have equal power. No improvement in the actual RF power will be obtained by optical processing. Furthermore, no improvement in the RF power for a given optical mean power will be obtained. This may appear counter-intuitive, because optical processing removes optical modes so that only modes spaced at the desired harmonic frequency are left, as shown in Fig. 4. The remaining modes mix at the photodiode to give the RF power at the desired harmonic of the laser drive frequency. The removal of optical modes reduces the mean optical power, as desired. However, we must not forget that *all pairs of modes spaced at the desired RF frequency* will contribute to the desired RF power. Because the contributions from the mode pairs are phase locked, then the RF power will equal the square of the number of modes. Thus, removing modes reduces the RF power. The net advantage of optical processing for pulses approaching delta functions, in terms of RF power to mean optical power, is nil.

However, for wider pulses the extent of the optical spectrum will be limited, as shown in Fig. 4(b). Modes can be removed that do not have a possibility of mixing to produce the desired RF frequency, and so an advantage in terms of RF power for a given mean optical power, can be gained. As shown in [2, eq. (5)], the break point for when optical processing is appropriate is when the pulsewidth FWHM is wider than approximately one quarter of the output pulse period. However, we shall show

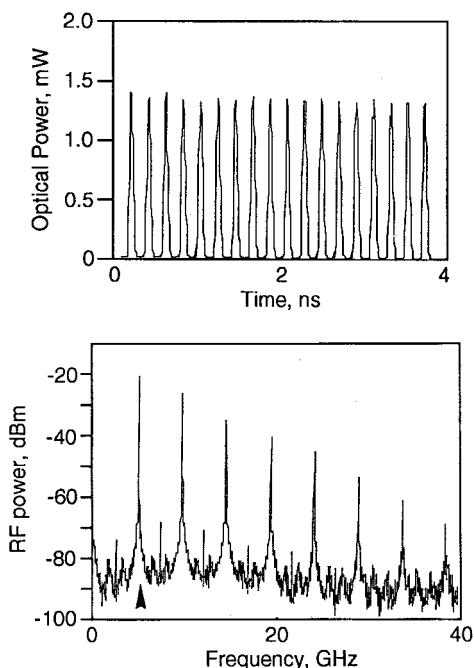

Fig. 5. Simulated pulse waveform and RF spectrum for the split-delay-recombine method with $n = 2$.

that the performance of the split-delay-recombine method degrades for such pulses, due to overlap of successive pulses' tails.

The split-delay-recombine method introduces power loss due to the recombining couplers, which have an intrinsic loss of 3 dB (optical) if only one output is used. This leads to a power loss of 6 dB in the desired RF signal. If multiple delays are used, then the loss will be greater. One method of eliminating the loss is to couple the outputs of each delay directly to the photodiode surface (although this is inappropriate if the aim is to transmit the optical signal along a fiber after processing). Due to the fact that we are not relying on optical mixing of the delayed versions of the pulses, then it is not essential that all the powers arrive at the photodiode in the same optical mode; indeed, separate modes would prevent amplitude patterning due to coherent mixing in the case of overlapping pulse tails. Alternatively, a polarizing beam splitter for recombining the paths or multiple photodiodes in parallel could be used.

The simulated pulse train and RF spectrum for a single-delay system, set to select even harmonics by using a delay equal to half the drive frequency period, are shown in Fig. 5. The doubling in pulse repetition frequency is evident, along with a 75% reduction in peak pulse power of an individual pulse due to the splitting and combining loss of the couplers, and a 50% reduction in mean optical power. The loss in the RF power at the 2nd harmonic is 6 dB; thus, there is no improvement in the ratio of the RF power to mean optical power squared. This is expected as the pulses are short compared with the period of the desired harmonic. The CNR at 100-MHz offset of the 2nd harmonic was -118 dBc/Hz, and was -84 dBc/Hz for the 16th harmonic. These are slightly worse than for the unfiltered case.

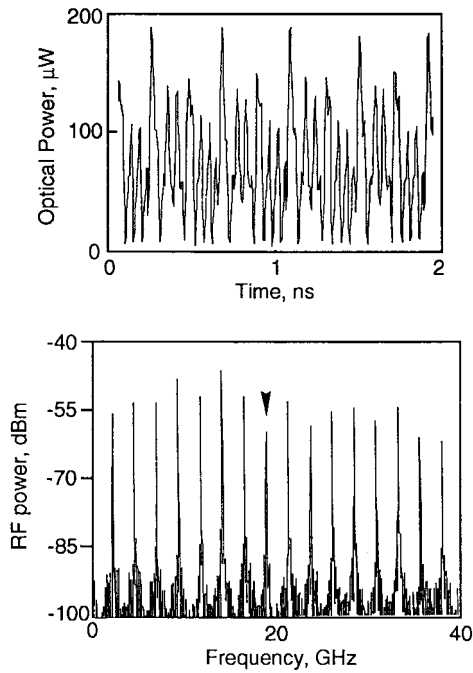

Fig. 6. Simulated pulse waveform and RF spectrum for the split-delay-recombine method with $n = 8$.

The RF spectrum in Fig. 5 shows excellent suppression of the odd-numbered harmonics; the fundamental is suppressed to 54 dB below the 2nd harmonic. The RF spectrum is relatively insensitive to the time delay. However, further simulations with eight delay paths to select the 8th and 16th harmonics, showed that when the pulse's fields overlap, amplitude patterning occurs, i.e., the amplitudes of a group of pulses within each fundamental drive period will take on a definite pattern. This pattern will repeat, provided the mode-locked laser is stable, as shown in Fig. 6. The resulting RF spectrum includes many harmonics of similar power. The patterning can be reduced if the delays are all tuned to a precise optical phase, so that the tails of the delayed pulses destructively interfere. However, such a system would be difficult to maintain in tune.

B. FPI [Fig. 2(b)]

The FPI can be used to select a comb of frequencies spaced by the FSR of the interferometer. With careful adjustment of the mode-locked laser and the RF drive frequency, the FPI's comb can be made to line up with the output spectrum of the mode-locked laser, and thus selects a set of equally spaced modes from the original spectrum [1], [2]. These modes will mix at the photodiode to give the desired harmonic of the laser drive frequency.

The major difference between the split-delay-recombine method and the FPI is that the impulse response of the FPI is infinite, having the form

$$h(t) = (1 - R) \sum_{n=0}^{\infty} R^n \cdot \delta(t - (2n + 1)t_{\text{delay}}) \quad (3)$$

where R is the power reflectivity of the mirrors, and t_{delay}

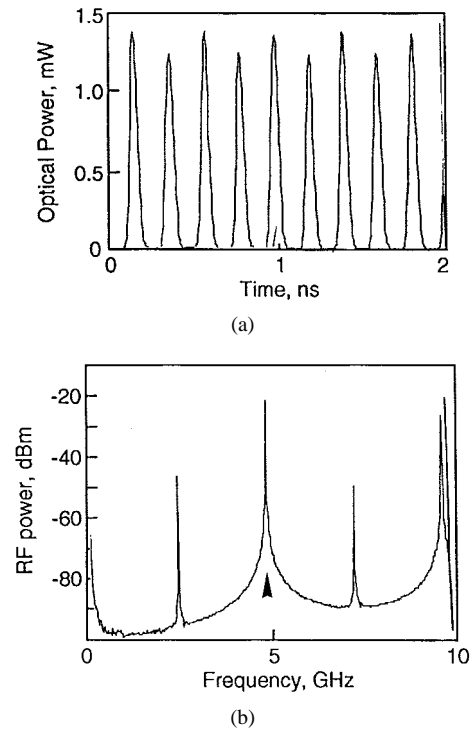

Fig. 7. Simulated pulse waveform and RF spectrum for the FPI method with 95% mirrors set to select even harmonics.

is the single-pass delay of the FPI. The time constant of the decay in intensity is approximately $t_{\text{delay}}/(1 - R)$.

Thus, for every pulse of the mode-locked laser, the FPI produces an exponentially decaying pulse train. If the FPI is tuned to select the even harmonics, the $n = 0$ and $n = 1$ terms in the summation mimic the form of the impulse response of the split-delay-recombine method, provided that R is close to unity. The $n = 1$ provides a "fill-in" pulse. However, terms $n = 2$ and above are problematic because they mix with subsequent pulses from the laser. The mixing is of the optical field so that for constructive interference, the optical pulses must have some pulse-to-pulse coherence, and the phase of the delay of the interferometer must be adjusted to a fraction of an optical wavelength. The mixing also means that any optical phase noise in the mode-locked laser will be translated to amplitude noise in the pulse train. This problem is worse the longer the decay time of the FPI is, because the bandwidths of the FPI passbands will be narrower. This implies a compromise between keeping the second term large, to reduce periodic amplitude variations due to the "fill-in" pulses being smaller than the main pulses, and reducing the conversion of optical phase noise to amplitude noise by coherent mixing of the mode-locked laser pulses. Fortunately, we shall show that mode-locked lasers retain a good degree of optical coherence from pulse-to-pulse because of their external cavity which "seeds" a new pulse from a previous pulse.

Fig. 7 shows the pulse train and RF spectrum using an FPI to select the second-harmonic (and, hence, all even harmonics) of the mode-locked laser. The FPI's mirrors had a 95% power reflectivity. The pulse train shows that alternate pulses have a power of 90% of the larger pulses. The expected power reduction is simply given by the square of the ratio of the

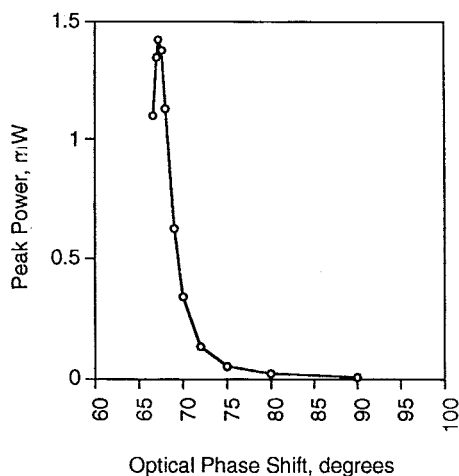

Fig. 8. Simulated tuning curve for the FPI method with 95% facets.

first and second terms of the summation in (1), which is $(0.95)^2$ or 0.90, as observed. The RF spectrum in Fig. 7(b) shows a reasonable suppression of the unwanted harmonics; the amplitude of the fundamental is suppressed to 24.5 dB below the 2nd harmonic power. The loss at the 2nd harmonic, compared with the unfiltered case, is 6.3 dB, similar to the *split-delay-recombine* method. This compares with 6 dB expected from (1) when half of the optical modes are suppressed; the optical spectrum showed alternate modes suppressed by 30 dB. The 38.3-GHz harmonic was reduced by 7.5 dB from the unfiltered case.

The optical phase within the FPI cavity was adjusted in 0.5° steps to obtain the maximum output for the above results, effectively tuning the FPI transmission peaks to the peaks of the mode-locked laser's spectrum. The tuning was critical, as is shown in the tuning curve for 95% mirrors in Fig. 8. The tuning curve reflects the transmission spectrum of the FPI, assuming that the mode-locked laser modes have a very narrow linewidth. Thus, the bandwidth of the 90%-mirror FPI is 125 MHz, as expected from the mirror reflectivities and the FSR [16]. The simulation shows how critical the adjustment of the FPI is to obtain a reasonable output power. In reality, a control system could be used to adjust the optical phase of the FPI for maximum output. Increasing the mirror reflectivities to 99% increased the suppression of the fundamental to 38.5 dB below the 2nd harmonic, due to the fill-in pulses being greater in amplitude, but increased the loss in the 2nd harmonic to 9.5 dB, possibly due to nonoptimum tuning. With 80% mirrors, the fundamental was 11.8 dB below the 2nd harmonic, and 19 dB with 90% mirrors.

We repeated the simulation, but with the FPI tuned to reject all but the 16th harmonic, and with 99% mirror reflectivities to maintain a reasonable decay time despite an increased FSR. The optical spectrum, time waveform, and RF spectrum are shown in Fig. 9. The FPI was tuned to obtain a large mean power, but with a reasonable modulation depth. The optical spectrum shows that the FPI selects an optical mode close to the dominant wavelength of the mode-locked laser, and a higher frequency mode with a much lower power. Because the two phase-locked modes selected by the FPI are of unequal

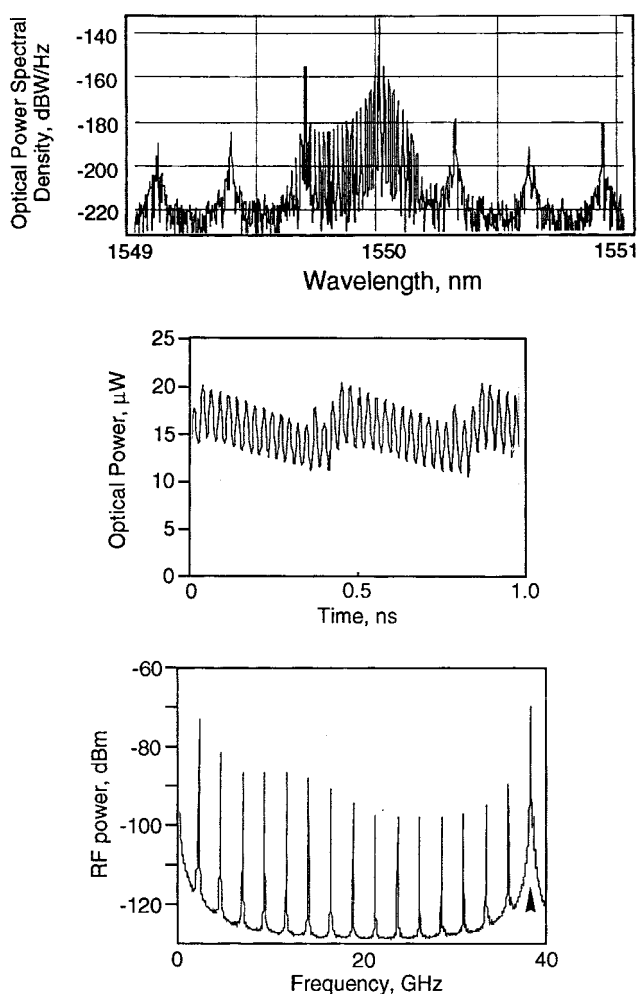

Fig. 9. Simulated optical spectrum, pulse waveform, and RF spectrum for the FPI method with 99% mirrors set to select the 16th harmonic (38.3 GHz).

power, the modulation depth shown in the power waveform is less than 100% and, thus, the ratio of RF power to mean optical power is not optimum. Tuning the grating of the laser would allow two modes of equal power to be selected if desired. An RF power of -68.5 dBm was obtained at the 16th harmonic of the drive frequency, only 6.5 dB less than the unfiltered case. Other harmonics were suppressed by up to 25 dB relative to the 16th harmonic. However, the fundamental's power was only 3.5 dB less than the 16th harmonic due to the decay in the optical power between the laser pulses. The mean optical power if the dc offset and fundamental component are ignored was $2.5 \mu\text{W}$. This translates to a theoretical RF power of -68 dBm, assuming that the pulses are too long to be considered as delta functions. Thus, when correctly tuned, the FPI method has a low loss, and could significantly improve the ratio of the RF power to mean optical power squared if two optical modes of equal power are selected by adjusting the lasing frequency. The CNR was -101 dB/Hz at 100-MHz offset, an improvement of 16 dB on the unfiltered case.

C. Separate Bandpass Filters [Fig. 2(c)]

A third solution is to use an optical bandpass filter (such as a multilayer filter or a combination of FPI's and multilayer

filters) to filter each desired optical mode. The minimum number of filters is two: to provide two optical modes which are mixed before photodetection to provide the microwave signal at their difference frequency. The filters are inserted after an optical splitter, and their outputs combined before photodetection. Thus, they are essentially inserted within a Mach-Zehnder interferometer.

The filters will have impulse responses similar to a decaying second-order resonance. The combined responses of the two filters will have the form

$$h(t) = k \cdot e^{-t/\tau} (\sin(2\pi f_1 t) + \sin(2\pi f_2 t)) \quad (4)$$

where k is an amplitude constant, τ is the decay time-constant of the optical fields in the filters, and f_1 and f_2 are the frequencies of the two optical modes. The decay time constant is related to the quality factor Q of the filters by

$$Q = \pi \cdot \tau \cdot f_{1,2}. \quad (5)$$

The resonances of the filters will be excited by the pulsed optical carrier from the mode-locked laser. If the filters are correctly tuned, then the excitations from consecutive pulses will constructively interfere, keeping the resonance at a near-constant value. The filters have to have a very high- Q factor, so that they store enough energy between excitations to keep the RF signal at a constant value. Thus tuning is critical. Optical phase fluctuations in the optical wave will be converted to amplitude fluctuations in the RF wave.

When the outputs of the two filters are mixed together and then detected, the RF photocurrent will be simply the envelope of the two optical waves. Thus the output should be a pure sinusoid, at $|f_1 - f_2|$, if the amplitudes of the outputs of the two filters are constant. The decay time constant of the optical power needs to be several pulse periods in order for the power of the “fill-in” pulses not to be substantially lower than the main pulses. For a power decay time constant of 1.275 ns (the same as the 95% FPI), this implies a field time constant of 2.55 ns, $f_1 = 193$ THz, thus $Q = 1600000$. This equation shows that extremely high Q factors have to be used. These can only be obtained using FPI's with long cavities and high reflectance mirrors, with additional bandpass filters to eliminate the multiple passbands of the FPI's. The relation between Q and FSR of an FPI with mirror (power) reflectivities R for an optical frequency f_0 is

$$Q = \frac{2f_0}{\text{FSR} \cdot (1 - R)}. \quad (6)$$

Thus, there is a design tradeoff between large FSR and mirror reflectivity. A large FSR will reduce the demands on the additional bandpass filters.

We simulated the system using Lorentzian responses to represent the bandpass filters. Fig. 10(a) shows the time-domain output of the filter system, and Fig. 10(b) shows the RF spectrum. The filters were tuned to the main mode at 1550.05275 nm, at which the mode-locked laser produced an optical power of 90 μW , and a side mode at 1550.01465 nm (63- μW power)—that is a separation of twice the laser drive frequency. The outputs of the filter system showed an optical loss of 6 dB, which is totally due to the splitting and combining

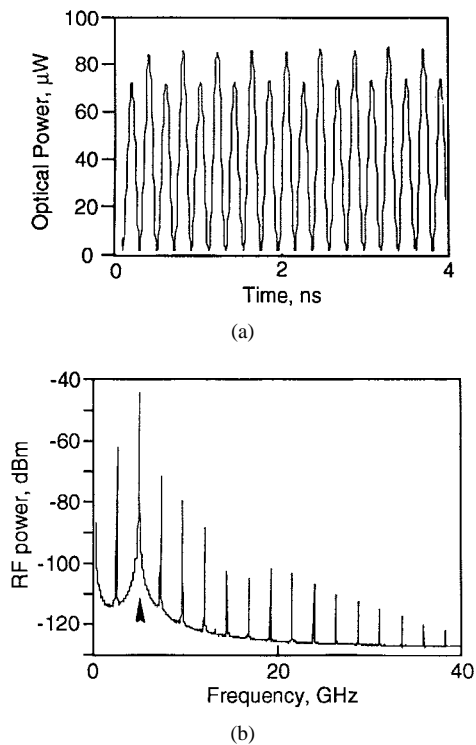

Fig. 10. Simulated pulse waveform and RF spectrum for the two-filter method set to select the 2nd harmonic.

couplers. The time-domain output is nearly sinusoidal; however, the peaks of alternate pulses are reduced in amplitude. The mean power at the output of the recombiner was 41 μW with some amplitude noise. This suggests an RF power of -43.8 dBm should be available, assuming that the optical envelope is sinusoidal as it should be with only two optical modes. The simulated RF power was -43.6 dBm, slightly above what was expected, due to the amplitude fluctuations making the mean powers difficult to track. This RF power is far below the FPI or split-delay-recombine methods because the majority of the optical spectrum is filtered out in each of the paths. However, the advantage of this technique is that all the unwanted harmonics have been suppressed. The fundamental was 18 dB below the 2nd harmonic, and all other harmonics were below this power. The noise at 100-MHz offset from the 2nd harmonic was -117 dBc/Hz, showing no CNR degradation due to filtering. Thus, the linewidth of the mode-locked laser must be well within the passband of the filters [17].

We also used the filters to select the 38.3-GHz harmonic. The filters were tuned to 1549.823 nm and 1550.129 nm to obtain modes with nearly equal powers on either side of the dominant mode. The pulse waveform and RF spectrum are shown in Fig. 11. The pulses show groups of decaying pulses due to the periodic excitation of the filters by the mode-locked pulses. A mean optical power of 2.8 μW was obtained, giving a theoretical power of -67 dBm. The simulated RF spectrum gave -70 dBm, only 8 dB below the unfiltered case. The CNR (100-MHz offset) improved from the unprocessed value of 85 dBc/Hz to 97 dBc/Hz, suggesting that the noise is reduced by the filtering. Other harmonics were suppressed to

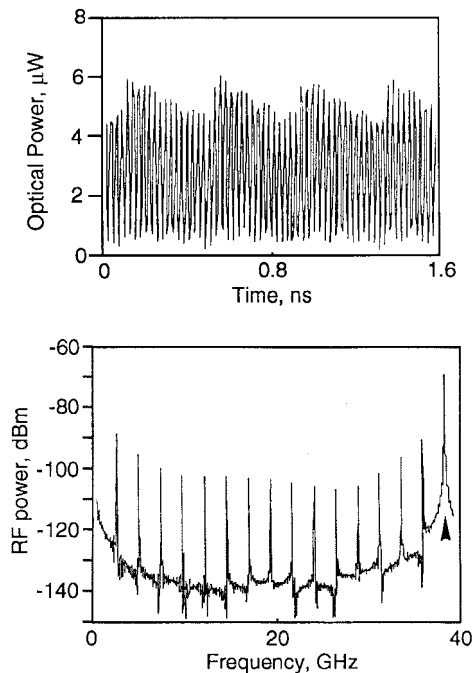

Fig. 11. Simulated pulse waveform and RF spectrum for the two-filter method set to select the 16th harmonic (38.3 GHz).

more than 17 dB below the desired harmonic. With optical amplification, higher output powers could be obtained [2]. Thus, this method is at least equal in performance to the FPI when high harmonics are required, and has more flexibility in choosing which pair of optical modes are selected without tuning the laser.

IV. GAIN-SWITCHED LASER

Novak *et al.* [2] used a gain-switched laser as a source of short pulses in a system using an FPI to select modes 37.1 GHz apart from a laser gain switched at 2.65 GHz. The resultant RF spectrum contained many unwanted spectral peaks.

To test the use of a gain-switched laser with an FPI, we repeated the simulations using a quarter-wave-shifted DFB laser model as a source. The laser was driven with 90-mA peak-to-peak sinewave superimposed on a 60-mA bias. The laser emitted pulses with a peak power of 32 mW and a width of 50 ps. Fig. 12 shows the pulse waveform and RF spectrum after processing to select the even harmonics. No tuning of the interferometer could be found that gave pulses with a stable amplitude; the pulse amplitude varied in a similar manner to a random walk from almost zero to an amplitude of 10% of the unfiltered pulse power. The RF spectrum showed broadened spectral peaks due to this amplitude modulation, giving a CNR of -80 dBc/Hz at 100-MHz offset. Similar amplitude fluctuations would occur with the two-filter method, as it also relies on long-term coherence between pulses. In contrast, simulations using the split–delay–recombine method showed stable pulse amplitudes for $n = 2$, and an RF power of -6 dBm with a CNR of -102 dBc/Hz, limited by the RIN of the laser. This is because the optical phase coherence between subsequent pulses is unimportant in this technique if the pulses are short compared with the period of the desired harmonic.

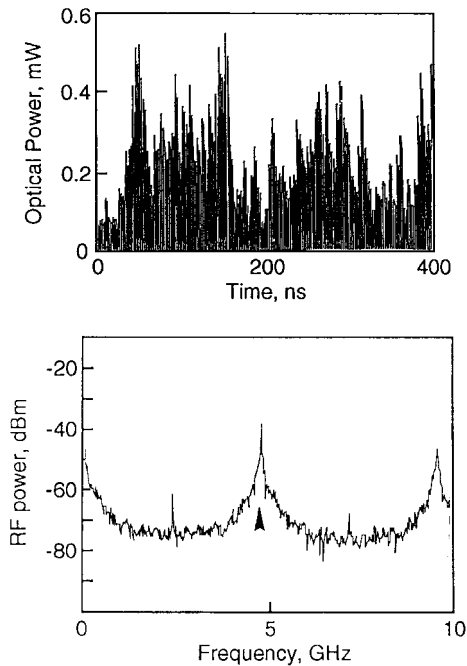

Fig. 12. Simulated pulse waveform over a long time period for the gain-switched laser/FPI method, and RF spectrum of pulse train.

V. CONCLUSION

The manipulation of the optical spectrum to select a higher baseband harmonic of a modulated laser is a useful technique for generating optical modulation well above the relaxation oscillation peak of a laser. Of the three optical filtering methods studied here, the split–delay–recombine method is least sensitive to the coherence of the source, and also provides minimum periodic amplitude variations due to the perfect storage mechanism (the delay) which provides “fill-in” pulses of equal amplitude to the original pulses. Provided the mark to space ratio of the laser pulses is small, this method is insensitive to the pulse-to-pulse optical coherence of the laser. It is, therefore, ideal for gain-switched lasers. However, if the pulses are wide (which, unfortunately, is when optical processing becomes useful in increasing RF power for a given mean optical power), then mixing between the tails of the pulses causes amplitude patterning and makes the adjustment of the delays critical. Additional splitters, delays, and combiners are required if rejection of more than the odd harmonics is required.

The two methods relying on optical filters are sensitive to the optical pulse-to-pulse coherence of the laser and are, therefore, only suitable for mode-locked sources. The FPI acts as a multiple delay, as energy bounces between the mirrors providing an infinite sequence of output pulses for a given input pulse. The mirror reflectivity must be high enough so that the decay rate of the impulse response is low enough to prevent fill-in pulses being significantly less powerful than the laser pulses, and this problem is compounded by the square-law relationship between optical and electrical power. However, high mirror reflectivities also make the passbands of the interferometer extremely narrow and, thus, tuning is critical. The coherence of the laser must also be long, but our

simulations showed that no additional noise was introduced when using a mode-locked laser source, thus the coherence time of the laser's modes must be significantly longer than the decay time of the filters.

The use of two separate filters in a split-filter-recombine system may appear attractive because the filters can be individually locked onto a pair of laser modes, and thus any multiplication of the laser drive frequency may be selected simply by moving the filters apart in frequency. However, again, the filters must have extremely high- Q factors in order to store enough energy for the "fill-in" pulses. Q 's of more than a million were used in these simulations. Such filters could be realized by Fabry-Perot filters combined with multilayer interference filters. However, the use of two filters is power inefficient for selecting low harmonics if the original spectral width is large, as all but two modes of the laser's spectrum are rejected. However, the efficiency is comparable with the FPI method if a high harmonic is required. This power inefficiency could be compensated for by optical amplifiers.

Finally, gain-switched lasers have very weak pulse-to-pulse coherence. Thus, methods using optical filters are unsuitable for such lasers, although the split-delay-recombine method is successful for low harmonics.

ACKNOWLEDGMENT

The authors should like to thank Dr. D. Novak for useful discussions.

REFERENCES

- [1] D. Novak and R. S. Tucker, "Millimeter-wave signal generation using pulsed semiconductor lasers," *Electron. Lett.*, vol. 30, pp. 1430-1431, 1994.
- [2] D. Novak, Z. Ahmed, R. B. Waterhouse, and R. S. Tucker, "Signal generation using pulsed semiconductor lasers for application in millimeter-wave systems," *IEEE Trans. Microwave Theory Tech.*, vol. 43, pp. 2257-2263, Sept. 1995.
- [3] K. Jackson, S. Newton, B. Moshlehi, M. Tur, C. Cutler, J. Goodman, and H. Shaw, "Optical fiber delay-line signal processing," *IEEE Trans. Microwave Theory Tech.*, vol. MTT-33, pp. 193-209, Mar. 1985.
- [4] D. Hunter and R. Minasian, "Reflectivity tapped fiber optic transversal filter using in-fiber Bragg gratings," *Electron. Lett.*, vol. 31, no. 12, pp. 1010-1012, 1995.
- [5] E. A. Swanson, S. R. Chinn, K. Hall, K. Rauschenbach, R. S. Bondurant, and J. Miller, "100-GHz soliton pulse train generation using soliton compression of two phase side bands of a single DFB laser," *IEEE Photon. Technol. Lett.*, vol. 10, pp. 1194-1196, Oct. 1994.
- [6] M. Pelusi, K. A. Ahmed, H. F. Liu, D. Novak, and Y. Ogawa, "Generation of 72 GHz pulse train from a passively mode-locked semiconductor laser using dispersion decreasing fiber," in *Proc. 20th Australian Conf. Opt. Fiber Technol. (ACOFT, '96)*, Coolool Beach, Australia, Dec. 3-6, 1996, pp. 409-412.
- [7] K. A. Ahmed, K. C. Chan, and H. F. Liu, "Femtosecond pulse generation from semiconductor lasers using the soliton-effect compression technique," *IEEE J. Select. Topics Quantum Electron.*, vol. 1, pp. 592-600, Feb. 1995.
- [8] R. S. Tucker, G. Eisenstein, and S. T. Korotky, "Optical time-division multiplexing for very high bit rate transmission," *J. Lightwave Technol.*, vol. 6, pp. 1737-1749, Nov. 1988.
- [9] A. J. Lowery, "Transmission-line modeling of semiconductor lasers: The transmission-line laser model," *Int. J. Numer. Modeling*, vol. 2, pp. 249-265, 1990.
- [10] A. J. Lowery, N. Onodera, and R. S. Tucker, "Stability and spectral behavior of grating-controlled actively mode-locked lasers," *IEEE J. Quantum Electron.*, vol. 27, pp. 2422-2430, Nov. 1991.
- [11] A. J. Lowery, "A new time-domain model for active mode-locking based on the transmission-line laser model," *Proc. Inst. Elect. Eng.*, vol. 136, pt. J, pp. 264-272, 1989.
- [12] A. J. Lowery and I. W. Marshall, "Numerical simulations of 1.5- μ m actively mode-locked semiconductor lasers including dispersive elements and chirp," *IEEE J. Quantum Electron.*, vol. 27, pp. 1981-1989, Aug. 1991.
- [13] Z. Ahmed, L. Zhai, A. J. Lowery, N. Onodera, and R. S. Tucker, "Locking bandwidth of actively mode-locked semiconductor lasers," *IEEE J. Quantum Electron.*, Special Issue on Semiconductor Lasers, vol. 29, pp. 1714-1721, June 1993.
- [14] A. J. Lowery, H. Olesen, G. Morthier, P. Verhoeve, R. Baets, J. Buus, D. McDonald, and D. D. Marcenac, "A proposal for standardised parameters for semiconductor lasers," *Int. J. Optoelectron.*, vol. 10, pp. 347-355, 1995.
- [15] R. J. Helkey, D. J. Derickson, A. Mars, J. G. Wasserbauer, and J. E. Bowers, "Millimeter-wave signal generation using semiconductor diode lasers," *J. Lightwave Technol.*, vol. 6, pp. 1-5, Jan. 1993.
- [16] A. Yariv, *Optical Electronics*, 3rd ed. New York: Holt, Reinhart and Winston, 1985, sec. 6.2.
- [17] D. W. Rush, G. L. Burdge, and P.-T. Ho, "The linewidth of a mode-locked semiconductor laser caused by spontaneous emission: Experimental comparison to single-mode operation," *IEEE J. Quantum Electron.*, vol. QE-22, pp. 2088-2091, Month 1986.



Arthur James Lowery (M'92-SM'96) was born in Yorkshire, U.K., on October 17, 1961. He received the First Class Honors degree in applied physics from Durham University, Durham, U.K., in 1983, and the Ph.D. degree from the University of Nottingham, Nottingham, U.K., in 1988.

He then worked as a Systems Engineer at Marconi Radar Systems. In 1984, he was appointed a University Lecturer at the University of Nottingham. In 1990, he moved to Australia to work as a Senior Lecturer in the newly formed Photonics Research Laboratory, University of Melbourne, Parkville, Vic., Australia. In 1996, he co-founded Virtual Photonics Pty Ltd., a company specializing in photonic CAD. He has authored or co-authored over 130 research papers in the fields of photonics and numerical modeling. His research interests include CAD of devices, circuits, and systems, DFB and mode-locked lasers, laser amplifiers, analog transmission, WDM, and photonic switching.

Dr. Lowery is a Chartered Engineer in Australia. In 1995, he was awarded the 1995 Australian Telecommunications and Electronics Research Board Medal for Outstanding Young Investigator.



Phil C. R. Gurney (M'94) was born in Leominster, U.K., in 1965. He received the B.Sc. and Ph.D. degrees in electrical and electronic engineering from Bath University, Bath, U.K., in 1988 and 1992, respectively.

In 1993, he joined the Photonics Research Laboratory, University of Melbourne, Parkville, Vic., Australia, where he has been working on CAD of photonic systems. In 1996, he co-founded Virtual Photonics Pty Ltd., a company specializing in photonic CAD. His research interests include semiconductor lasers, integrated photonic devices, and photonic millimeter-wave signal generation.